

 **sauermann**<sup>®</sup>

**KIMO**<sup>®</sup>  
INSTRUMENTS

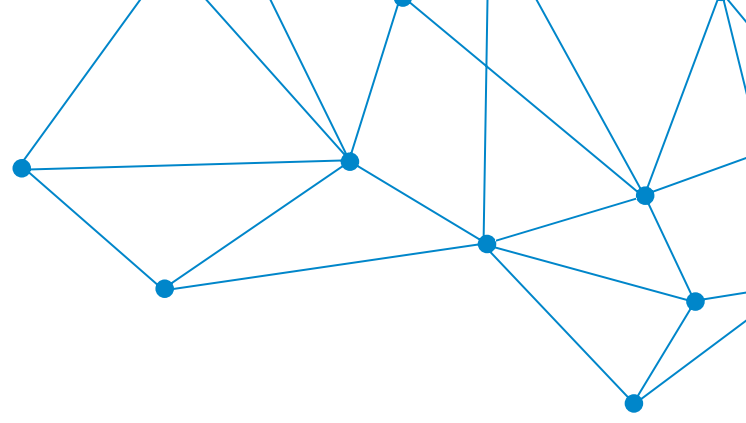

# CLEAN ROOMS AND REGULATED ENVIRONMENTS



# ABOUT US



Member of the Verder group, Sauer mann group has designed, manufactured and sold products and services dedicated to the industrial and HVACR markets for over 40 years. The group specifically focuses on the detection, measurement and control of indoor air quality (IAQ).



Member of the Verder group, Sauer mann group operates two main brands:

- The **Sauer mann** brand, through condensate removal pumps, instruments and accessories, primarily addresses the needs of Heating, Ventilation, A/C or Refrigeration contractors.
- The **Kimo** brand, through measuring instruments, meets the air management needs in light commercial and industrial installations.

HIGH ACCURACY  
UNMATCHED RELIABILITY  
MULTIPLE APPLICATIONS

**Measurement instruments:** Sauer mann measurement instruments monitor a broad spectrum of indoor air quality parameters and serve a wide range of applications, from building ventilation (heating and air conditioning) systems, to cold-chain installations and combustion gas analysis. Backed by our testing laboratories and in-house research and development programme, Sauer mann instruments deliver the accuracy and reliability that HVACR engineers need.

LOW SOUND LEVEL  
LOW FAIL RATE  
HIGH PERFORMANCE

**Condensate management solutions:** Safe and effective condensate management for air quality systems can be a challenge. Sauer mann pumps are designed to look good, while our patented piston technology delivers whisper-quiet operation and unrivalled reliability.

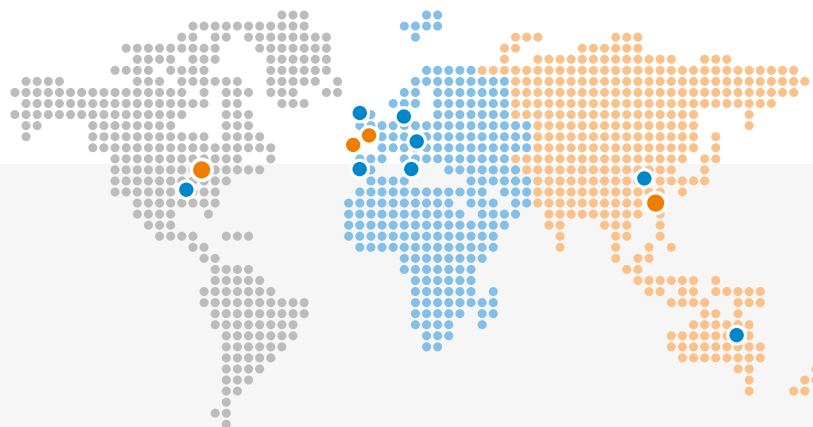

**North America**  
● Sauer mann N.A. Corp.,  
New York City,  
Yardley, PA, USA

**EMEA – Europe,  
Middle East & Africa**  
● Si Invest SA,  
Brussels, BELGIUM  
  
● Sauer mann Industrie S.A.S.,  
Chevry-Cossigny,  
Montpon, FRANCE  
  
● Sauer mann GmbH,  
Leingarten, GERMANY

● Sauer mann UK Ltd.,  
Blackpool, UNITED KINGDOM  
  
● Sauer mann Iberica,  
Barcelona, SPAIN  
  
● Sauer mann Italia S.r.l.,  
Bologna, ITALY

**Asia Pacific**  
● Sauer mann China,  
Shanghai (Jiading & Pudong),  
CHINA  
  
● Sauer mann Australasia,  
Sydney, AUSTRALIA

# SUMMARY

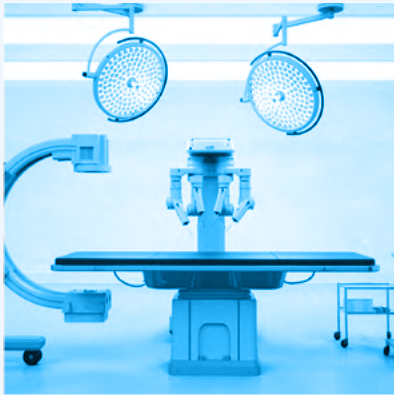

DATA LOGGING

21

MONITORING AND  
REGULATION

06



COMMISSIONING,  
VALIDATION AND  
MAINTENANCE

26

**About us** ..... 02

**Clean rooms** ..... 04

Flawless air quality  
management,  
guaranteed ..... 04

A world of standards  
and regulations ..... 05

**Monitoring and regulation** ..... 06

Multifunction ..... 08

Pressure ..... 10

Temperature and humidity ..... 12

Air velocity and air flow ..... 13

**Data Logging** ..... 14

All parameters ..... 16

**Commissioning,  
validation and maintenance** ..... 18

Multifunction ..... 20

Air velocity and air flow ..... 22

**Products and accessories** ..... 24

**For more information** ..... 36

# CLEAN ROOMS

## Flawless air quality management, guaranteed

In clean rooms, avoiding contamination depends on irreproachable indoor air quality management. That's why, for 45 years, Sauermann has been putting the best of its R&D expertise to work for these critical environments, which are subject to particularly stringent standards. Our aim, as always, is to manufacture the best products and to deliver an impeccable service to industry professionals.

### At the cutting edge across all sectors

Effective ventilation system management is essential in any sector where airborne particles such as dust, bacteria, viruses, micro-particles and aerosols can disrupt operations. At Sauermann, we work hand in hand with our partners in industries ranging from advanced electronics and pharmaceuticals to aviation, hospitals and biotechnology.

### Spanning every aspect of metrology

Sauermann harnesses the full breadth of its metrology expertise to help clean rooms adhere to stringent standards, from constant monitoring to ad hoc tests and everything in between: air flow balancing, certified calibration, and testing and repairing of measurement instruments for pressure, humidity, temperature, air velocity and air flow, CO<sub>2</sub> concentration and other parameters.

### The jewel in our crown

Controlled-environment buildings demand the very best monitoring and control instruments – certified and setting the gold standard for reliability. Sauermann has its own manufacturing facilities, in-house laboratories accredited to ISO 17025:2017, and a team of on-site technicians with the requisite expertise, all backed by a 45-year track record in metrology. That's why our customers rely on us to supply flawless measurement instruments, and to be there by their side for the long term.

## A world of standards and regulations

**Clean rooms undergo qualification and constant re-qualification** to strict standards, requiring advanced measurement instruments to make sure they meet the grade. In order to comply with these GxP quality and traceability regulations, they must keep records of the conditions in which they operate, in accordance with Good Manufacturing Practice (GMP) standards.

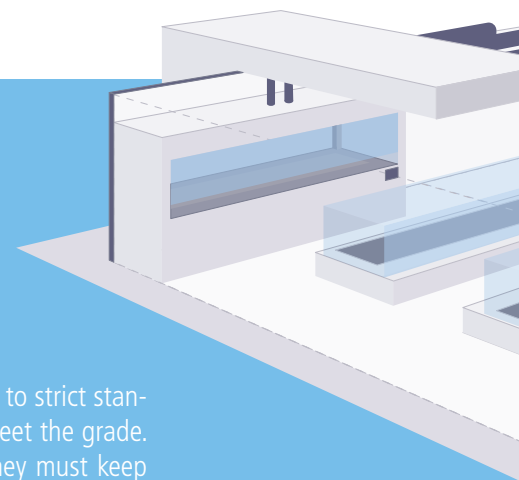

EN ISO 14644-1	Maximum permitted concentration (Particle per m <sup>3</sup> )					
	Class	≥ 0.1 μm	≥ 0.2 μm	≥ 0.3 μm	≥ 0.5 μm	≥ 1.0 μm
ISO 1		10				
ISO 2		100	24	10		
ISO 3		1 000	237	102	35	
ISO 4		10 000	2 370	1 020	352	83
ISO 5		100 000	23 700	10 200	3 520	832
ISO 6		1 000 000	237 000	102 000	35 200	8 320
ISO 7					352 000	83 200
ISO 8					3 520 000	832 000
ISO 9					35 200 000	8 320 000

## Fighting contamination with precision

In clean rooms, monitoring and control measurements rely on extremely narrow margins, especially when it comes to differential pressure. Each room has to be kept slightly above or below the pressure outside in order to prevent the risk of atmospheric contamination. Sauermann's instruments are designed to provide the measurement accuracy and resolution that these demanding applications require.

Air change rate is the speed at which all the air inside a room is replaced by the ventilation system. To calculate this rate (ACH), expressed per hour, the airflow rate of each inlet of the ventilation system is divided by the total volume of the room concerned.

Mathematically is expressed by this simple equation:

$$ACH = Q/V$$

ACH = number of air changes per hour

Q = air flow

V = space volume

The pressure differential between adjacent cleanrooms or clean zones of different cleanliness level should lie typically in the range of 5 Pa to 20 Pa, to allow doors to be opened and to avoid unintended cross-flows due to turbulence.

Source: ISO 14644-4; Cleanrooms and associated controlled environments Part 4: Design, construction and start-up

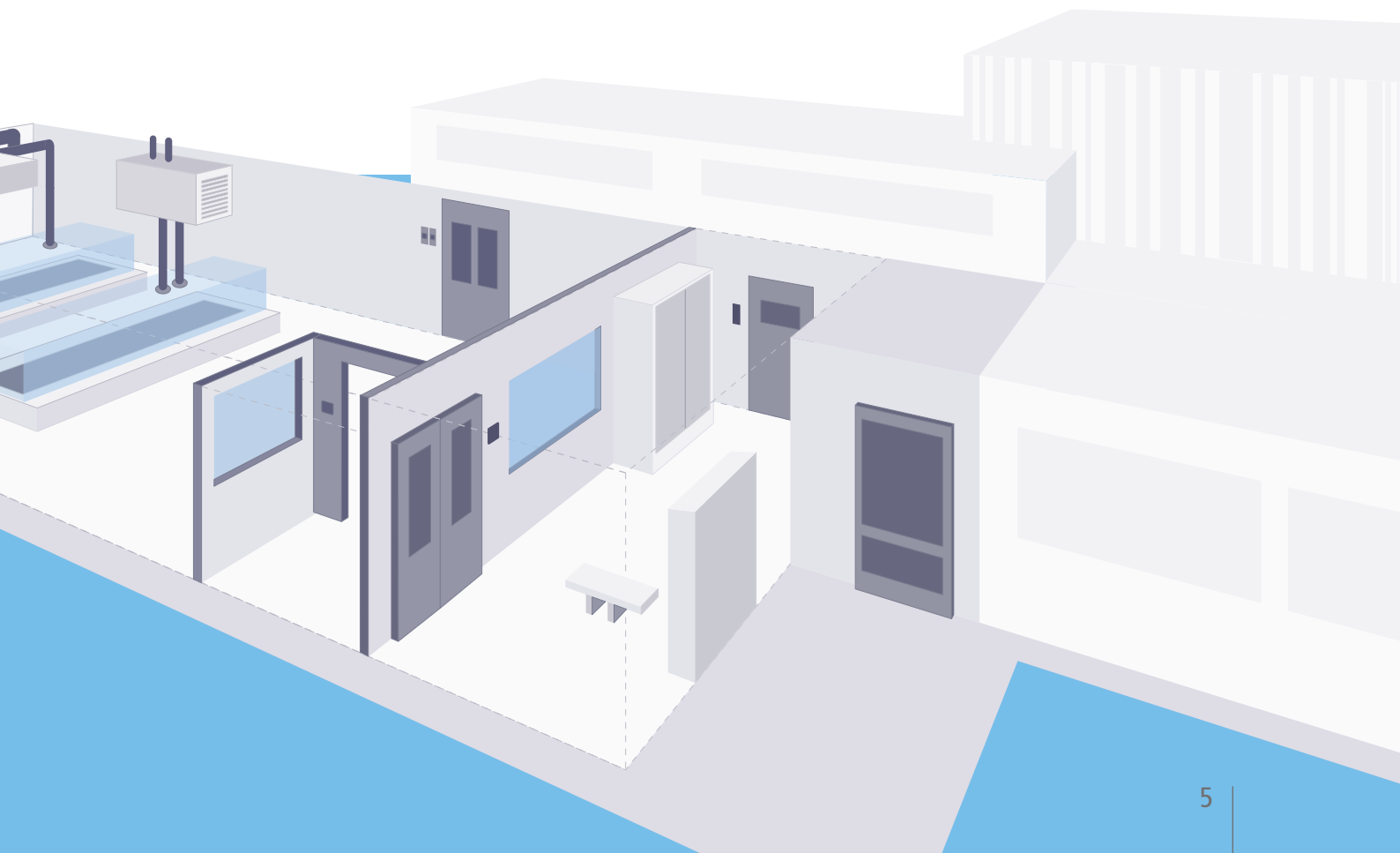

# MONITORING AND REGULATION

In clean rooms, air parameters need to be regulated and monitored around the clock. At Sauer mann, we put every inch of our expertise to work to develop premium measurement instruments that set the bar high for reliability, accuracy and durability.

This type of application requires multifunction transmitters, or transmitters specially designed to measure a specific parameter.

The constant monitoring system is linked to real-time regulation of the ventilation system via a network of instruments, which themselves are connected to a Supervisory Control and Data Acquisition (SCADA) system. This interconnected architecture, known as Building Automation, forms the core of Building Management Systems (in commercial applications) or Cen-

tralised Technical Management systems (in industrial premises) – automation systems that also optimise the building's energy use by analysing data collected by our measurement instruments.

That's why Sauer mann's transmitters are open by design, meaning have standard outputs – both analogue and digital. And our transmitters offer the ultimate in flexibility when it comes to Building Management System topology, structure and configuration.

The aim is to monitor air quality parameters non-stop and around the clock, to achieve flawless indoor air quality management and to support preventive maintenance of the ventilation system.

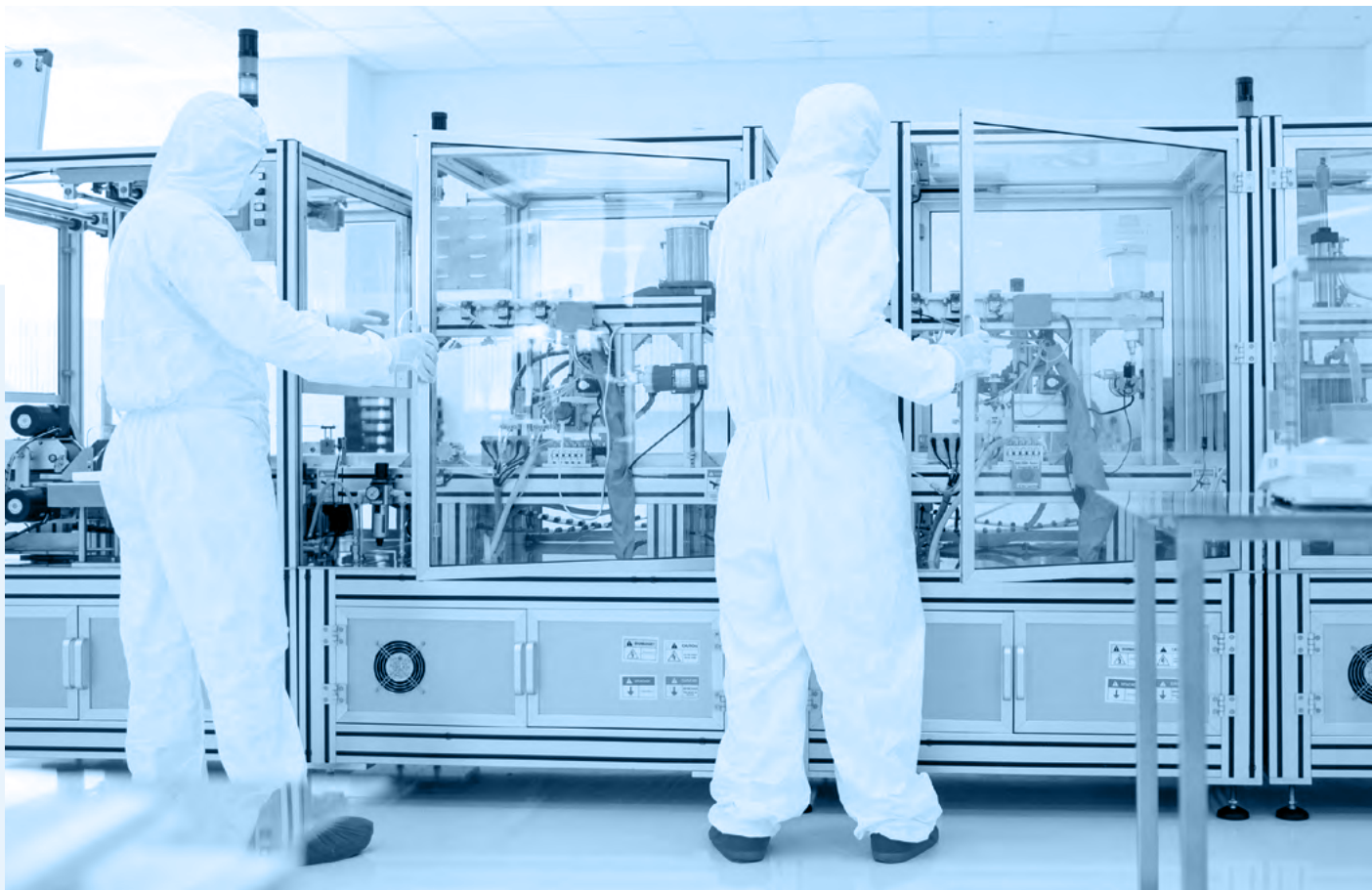

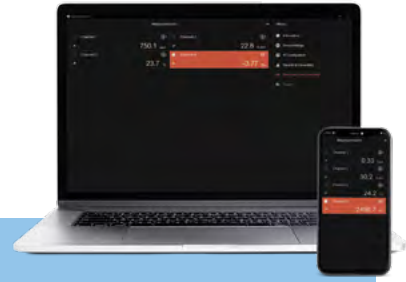

### LCC-S software and Sauer mann Control application:

Our classes 110 and 210 transmitters can be easily configured with any specific settings using the optional configuration software. This tool allows the users to get the most suitable performance out of class 100 and class 210 Sauer mann's transmitters. The software also displays the actual measurements in real time and allows to manage the outputs when needed.

The Class 320 transmitters can be controlled and configured with a computer, a smartphone or a tablet via the Sauer mann Control application, which allows the user to manage all the device's parameters via its wireless connection module (USB wired for computers). This app can also easily update the firmware of the instrument and its probes.

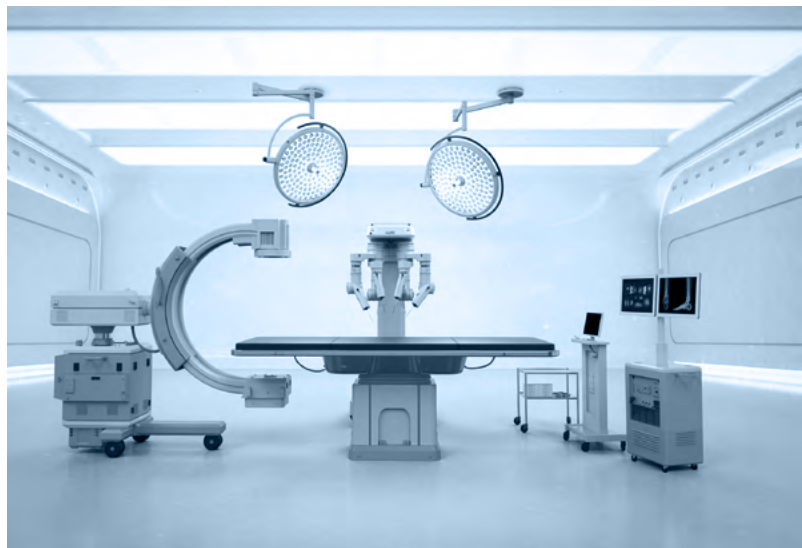

## Monitoring and regulation

# Multifunction transmitters

Sauermann's multifunction transmitters are the most advanced instruments of their kind in our range – and the go-to choice for round-the-clock monitoring of clean room environments.

These instruments are designed with flawless, permanent operation in mind, leaving the rest of the market trailing when it comes to accurate, reliable measurement of a wide range of air parameters – including one of the most important parameters for professionals in regulated environments: differential pressure.

These transmitters can also accommodate additional probes for measuring and displaying up to four parameters simultaneously (pressure, temperature/humidity, air velocity, air flow, and CO/CO<sub>2</sub>/VOC concentration).

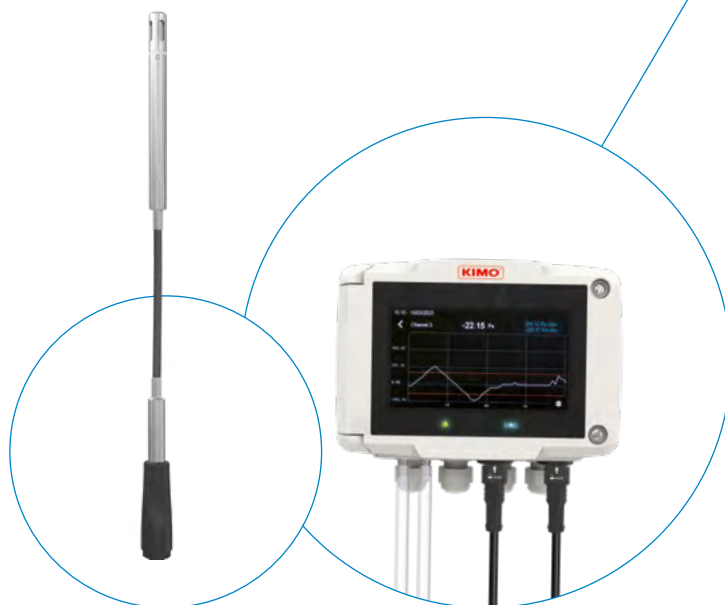

For measuring  
temperature and humidity.

### Solution

Si-C320-D with Si-PRO-V-300 and  
Si-PRO-U-I-150 probes



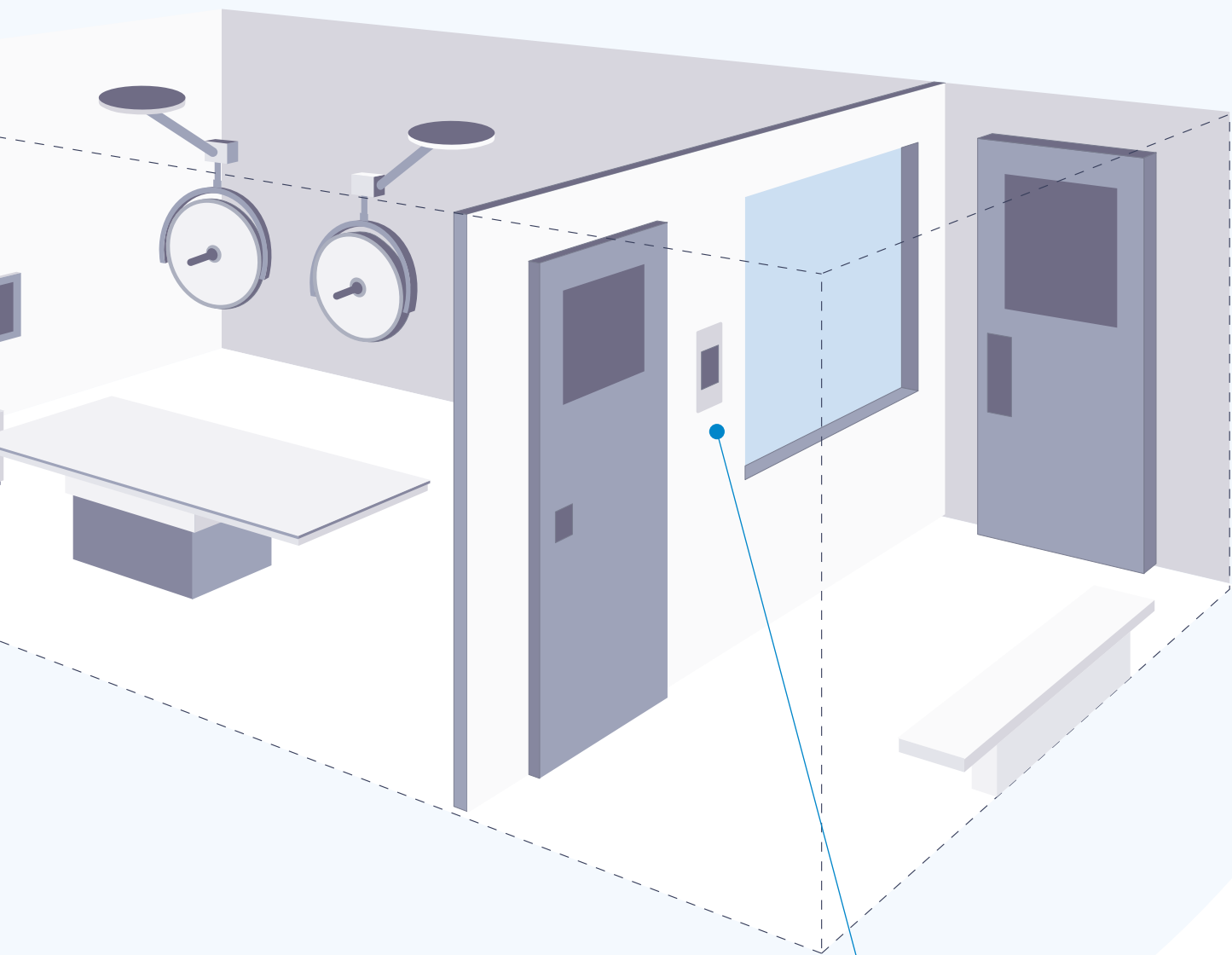

For monitoring and regulating differential pressure, temperature and humidity in pharmaceutical production facilities or in surgery rooms. The flushmount transmitter is located inside the room, and the additional probe is ideally installed in the ceiling or in the return air duct.

**Solution**  
Si-CPE320 with  
Si-PRO-U-I-150 probe



## Monitoring and regulation

# Pressure

Measuring pressure is especially important in regulating the incoming air dynamic pressure and monitoring air filters, which clog foul at different rates depending on their filtration efficiency. Differential pressure manometers also monitor high-side and low-side pressure in production rooms.

Differential pressure measurements in critical rooms are crucial to maintain the extremely low concentration of airborne particles. These measurements are used by the regulation systems to manage efficiently the ventilation in each area. Our differential pressure transmitters are renowned for their outstanding performance.

Flushmount transmitters also monitor zone-specific confinement in order to avoid atmospheric contamination in pharmaceutical production and hospital settings.

Building on its long-standing expertise in pressure measurement instruments, Sauermann's solutions – connected transmitters and liquid column manometers – cover every application. Our transmitters are ideal for recording values remotely and over time. Our liquid column manometers are unmatched when it comes to durability and function without a power supply, which makes them exceptionally resilient.

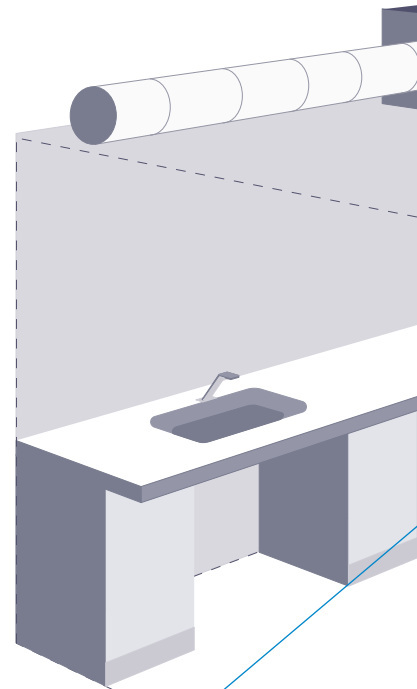

For regulating differential pressure in critical environments (pharmaceutical production facilities and operating theatres) using a differential pressure transmitter.

**Solution**  
CP 211

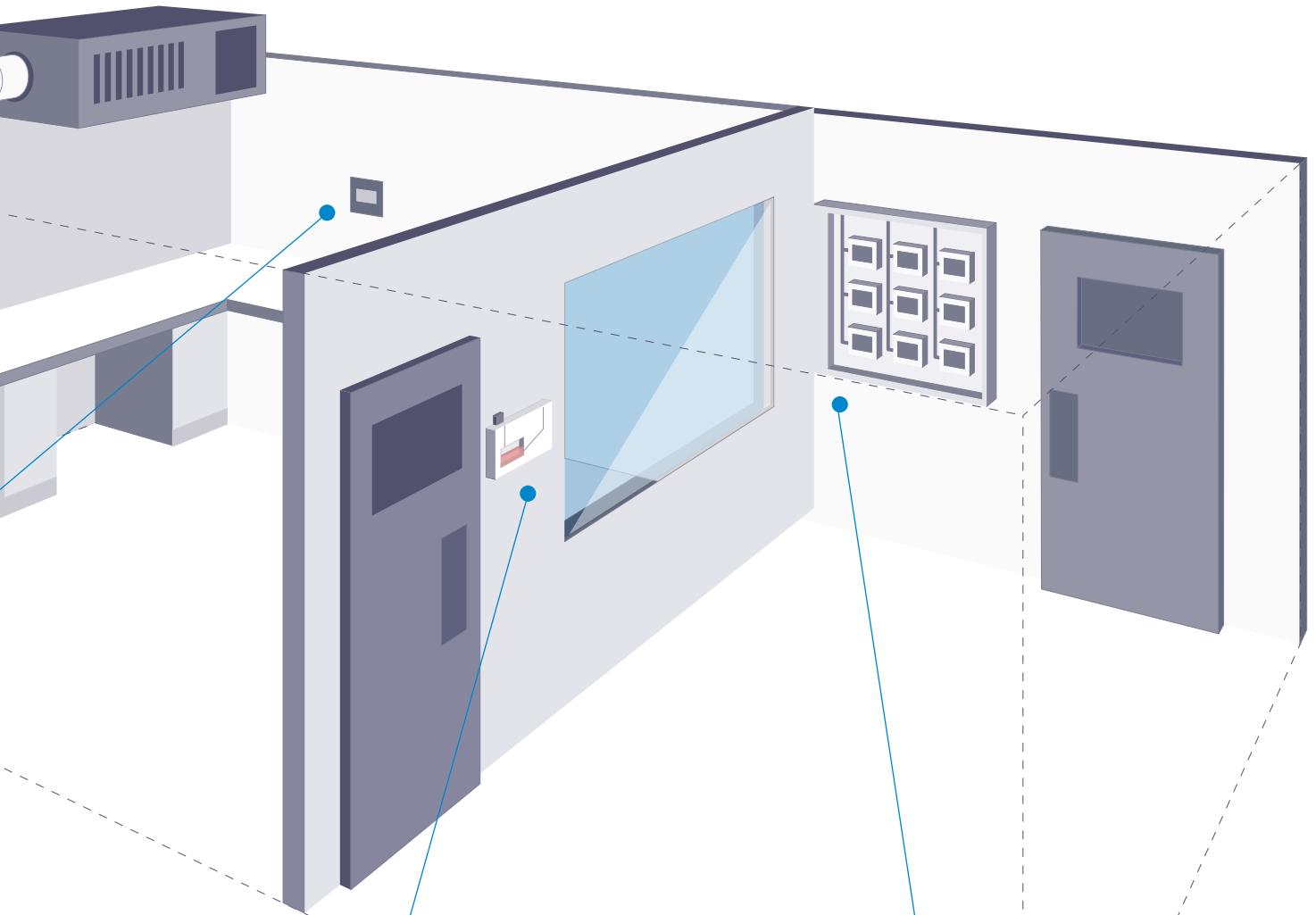

For permanently displaying the differential pressure at the entrance to clean rooms for laboratory technicians, without requiring a power supply.

**Solution**  
HP 5  
or HP 10



For monitoring differential pressure in clean rooms, to deliver efficient regulation and help to monitor the environment.

**Solution**  
CP 111

## Monitoring and regulation

# Temperature and humidity

According to ISO 14644-3, the ventilation system in a clean room must be capable of maintaining temperature and humidity values within operation-specific limits. These rules are designed to prevent common problems such as the expansion or contraction of materials, the spread of pathogens, and corrosion.

All Sauermann temperature transmitters measure relative humidity. They are used in all applications, and are especially popular in the pharmaceutical industry, where production zones often have to adhere to strict environmental standards for product preservation reasons.

These transmitters can also be found in storage and packing areas in health care, high tech and other critical manufacturing sectors.



For regulating temperature and humidity in packing areas in the pharmaceutical industry.

**Solution**  
TH 210-R

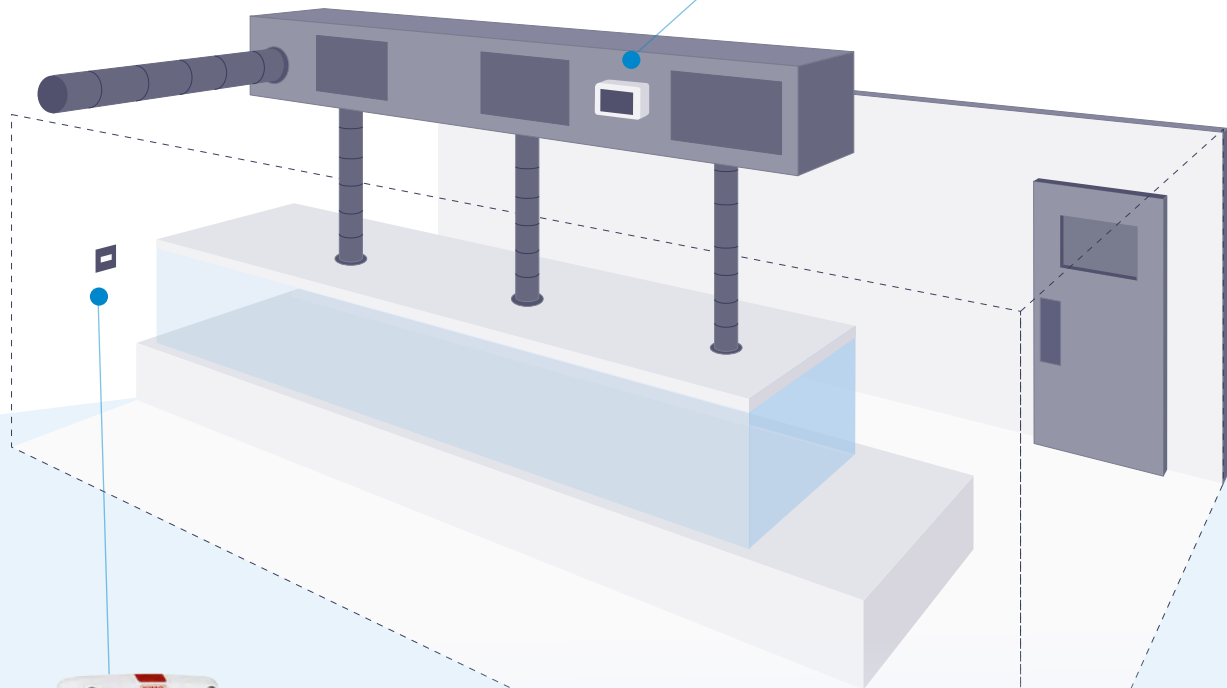

For regulating temperature and humidity in critical environments (clean rooms) using a transmitter.

**Solution**  
TH 110

## Monitoring and regulation

# Air velocity and air flow

The air flow through inlets and outlets needs to be precisely controlled in order to maintain a sufficient air change rate within different zones of a clean room complex. Meeting this stringent requirement becomes even more challenging when indoor air is purified by filters that capture bacteria, viruses and other airborne particles. These filters disrupt the air flow, potentially creating turbulence or reducing flow rates.

Clean rooms in the most stringent ISO classes (1-5) must have a turbulence-free laminar air flow that optimises air circulation and air change, while maintaining pressure at a sufficiently stable level to keep it above or below atmospheric pressure. Keeping check on the ventilation system to make sure it is perfectly balanced means measuring air flows around the clock.



For monitoring and regulating air velocity and air flow inside ventilation system pipes.

**Solution**  
CTV 110

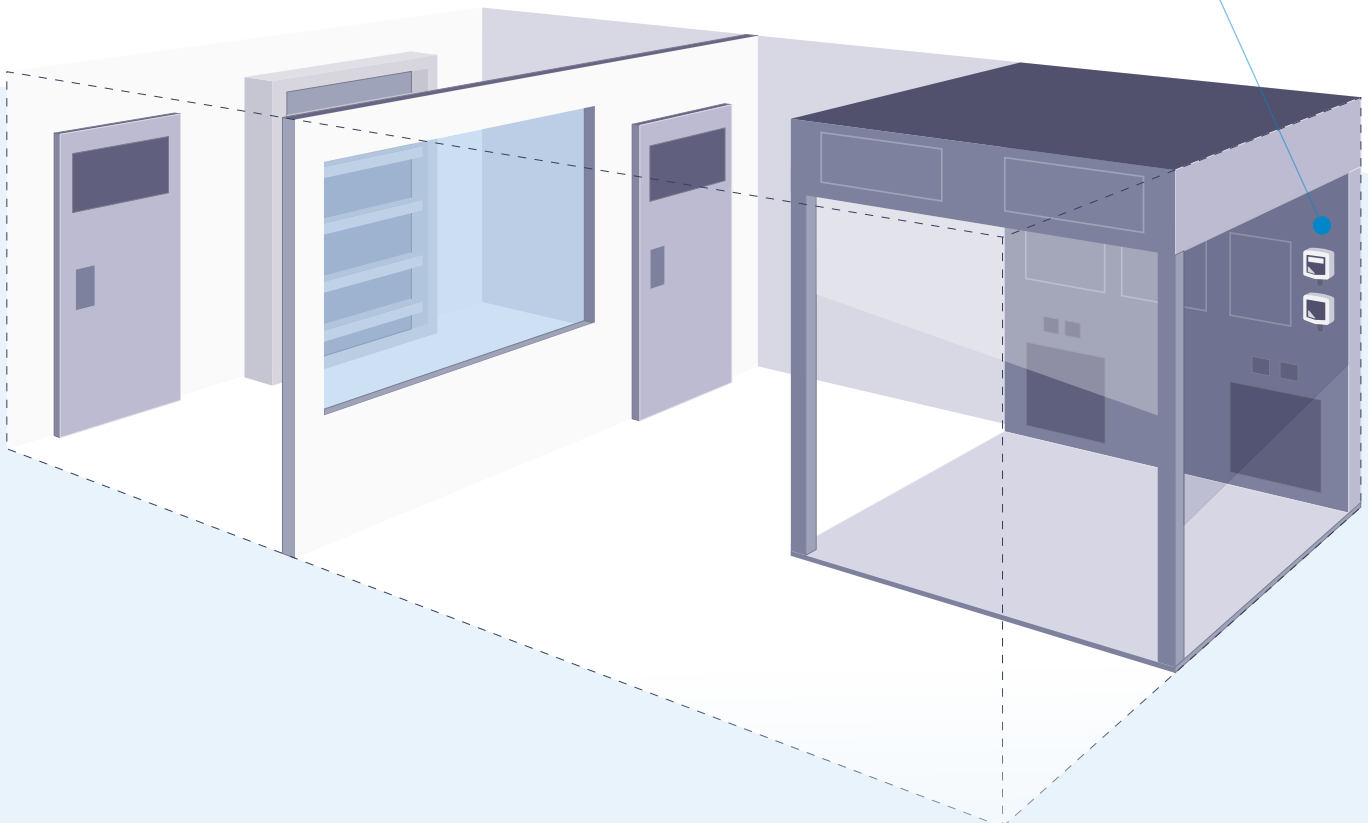

# DATA LOGGING

Complying with rules and standards for controlled environments involves several layers of monitoring. This includes measuring air parameters separately from regulating the building's ventilation system, which already has its own measurement and monitoring instruments. This second layer of monitoring has a dual purpose: to pick up potential regulation issues with the ventilation system, and to quickly check air quality conditions in critical locations and facilities (such as exhaust hoods and isolation chambers).

This monitoring task is performed by data loggers – fully autonomous instruments with a large internal memory and an integrated battery for power. These devices keep tabs on air quality parameters in a particular area. They can also operate as a grid, monitoring

all the air inside a room and providing an overview of how the ventilation system is performing.

- **Everyday monitoring on the fly**
- **Long-term mapping studies**

Our autonomous data loggers are small, lightweight portable and highly easy-to-use instruments designed for easy installation in any location and long-lasting operation. Readings can be downloaded to the accompanying software wirelessly or via USB in order to generate comprehensive measurement reports.

These instruments can also be used to produce a detailed map of regulated environments, in order to check air parameter uniformity within an entire space and over an extended period.





## KISTOCK Mobile: App for class 320 autonomous data loggers

This free app for Android and iOS devices pairs wirelessly with our data loggers for complete control:

- Supports an unlimited number of instruments
- Manage and configure data loggers remotely
- View readings in real time
- Display measurements as graphs and charts
- Generate PDF or spreadsheet measurements reports



### Mobile application

- Wireless pairing
- Data visualisation
- Free download

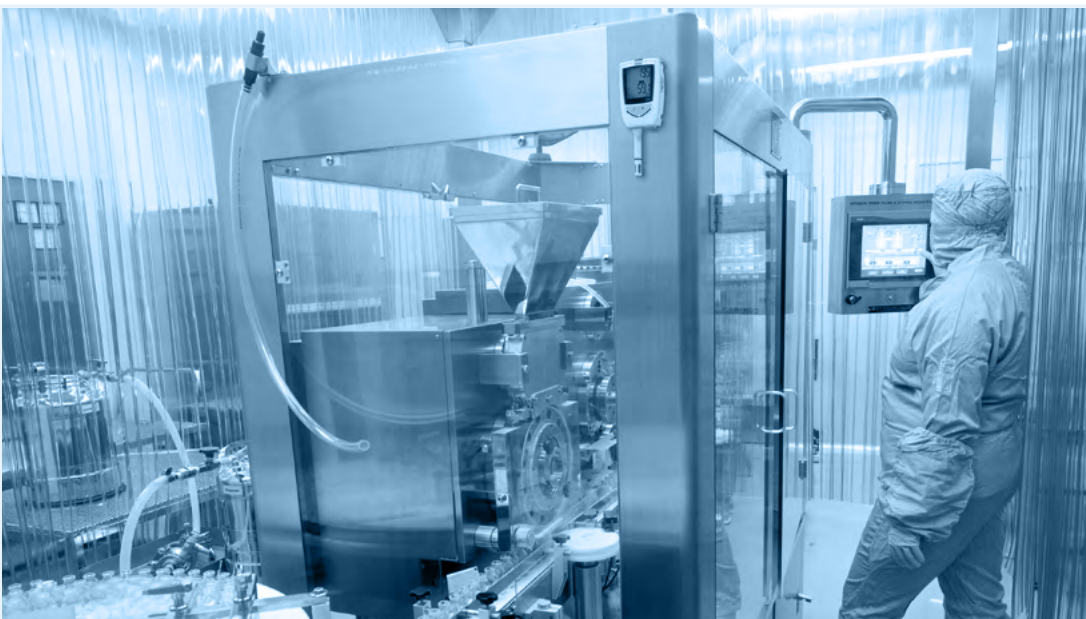

## Data logging

# All parameters

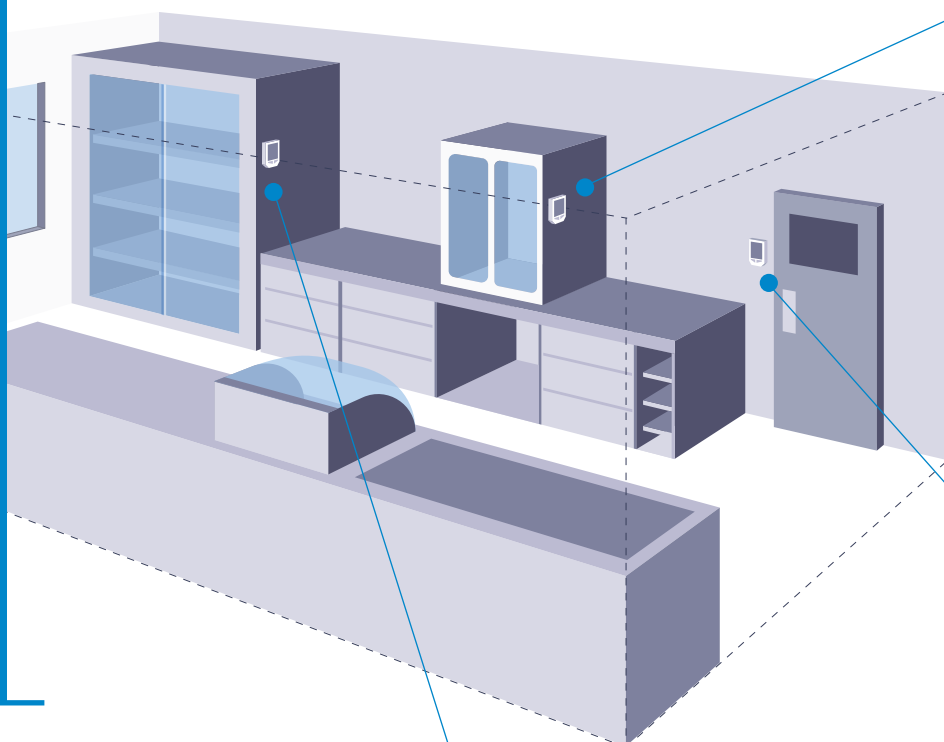

Records environmental conditions to make sure that humidity levels are properly regulated.

### Solution

KT 320, KH 220 or  
KT 220 with KITHA probe



Records CO<sub>2</sub> concentration (an indicator of indoor air quality and the air change rate) and atmospheric pressure in any type of laboratory.

### Solution

KCC 320



2 m long cable

Records the temperature inside two refrigerators, providing evidence of the storage conditions of heat-sensitive products (such as drugs, vaccines and biological samples) for traceability purposes.

### Solution

KT 320 with two KIRGA-50 Pt100 probes



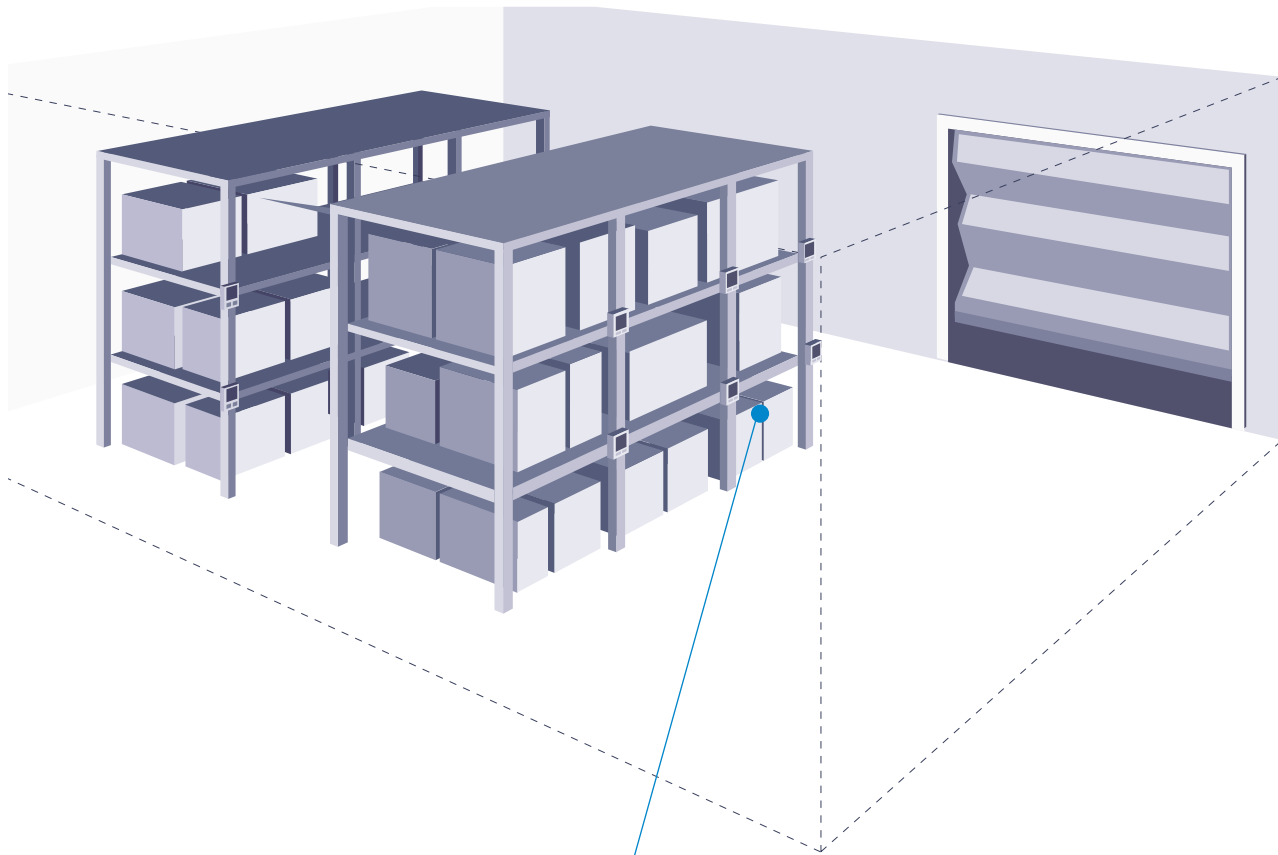

Records the temperature inside a storage facility for heat-sensitive products (such as pharmaceutical ingredients, finished products and perishable foodstuffs): one instrument can take up to three temperature readings simultaneously (two external probes and one internal probe).

**Solution**

Kistock KT 320  
with two KIRGA-50 Pt100 probes

# COMMISSIONING, VALIDATION AND MAINTENANCE

HVAC engineers are involved at various stages in the life of a ventilation system – starting with the commissioning phase, when they check that all the system components are designed, installed, tested and used in a way that meets the operational specifications set by the project managers and the customer. These vital checks ensure that the ventilation system operates as efficiently as possible right from the outset.

Validation is an important process for any cleanroom. It serves to ensure that the cleanroom is properly installed and designed for its intended ISO classification and that all of the components (facility, environment, equipment) meet regulatory requirements and other defined standards. Therefore, validation consist in “Establishing documented evidence that provides a high degree of assurance that a specific process will consistently produce a product meeting its predetermined specifications and quality attributes” (GMT Draft Annex 1).

“Our instruments are quick and easy to use while catering to every professional requirement.”

Aside from commissioning and validation, a building’s ventilation system will require routine preventive maintenance. Once again, this process involves measuring all relevant parameters in order to detect even the slightest problem or defect, with clogged filters being the most common issue.

Each of these tasks can only be carried out using premium, portable, lab-calibrated measurement instruments. Our instruments are quick and easy to use while catering to every professional requirement, saving engineers and technicians precious time and allowing them to focus on their core areas of expertise.





## Commissioning, validation and maintenance

# Multifunction

Commissioning and maintaining ventilation systems involves measuring a wide range of air parameters, from temperature, pressure, and air flow and velocity, to humidity, CO<sub>2</sub> concentration and more. That's why portable, multifunction instruments are the tool of choice for these tasks.

*"These instruments are specially designed with measurement precision and resolution in mind, adhering to the extremely fine margins required by controlled-environment standards."*

Sauermann has extensive expertise in manufacturing premium measurement instruments that deliver the high degree of accuracy required in laboratories, clean rooms and other critical environments. These instruments are specially designed with measurement precision and resolution in mind, adhering to the extremely fine margins required by controlled-environment standards.

Sauermann's portable multifunction devices are some of the most advanced commissioning, testing, balancing and maintenance instruments on the market. And because they're built for reliability, speed and user-friendliness, they help professionals work more efficiently. What's more, their modular design and range of attachable probes lets engineers build a custom measurement solution – all calibrated in Sauermann's in-house laboratories, which are accredited by COFRAC to ISO 17025:2017.



Measures all key parameters for ventilation system commissioning and performance management in a controlled-atmosphere environment.

### Solution

AMI 310

Probes:

Differential pressure: MPR 500

Humidity: SHR 110

Temperature: SPK 150

Hot wire: SFC 900

Vane: SH 100

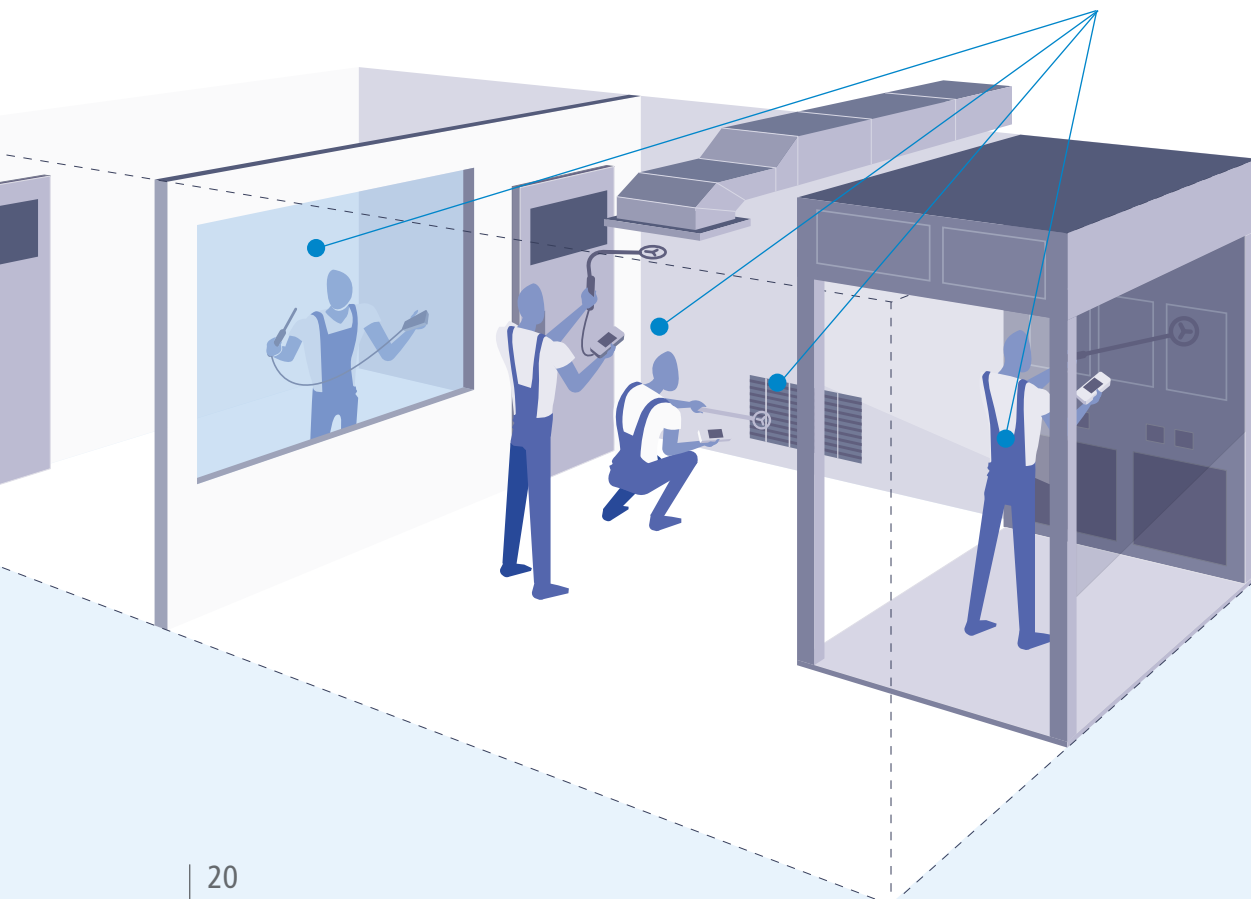



Modules and probes

HQ 210

VT 210

MP 210

AMI 310

Humidity  
Temperature  
CO<sub>2</sub> / CO

Air velocity  
Humidity  
Tachometry

Pressure  
Air velocity  
Tachometry  
CO

Multifunction  
All parameters



500 Pa Pressure Module  
MPR 500

-

-

✓

✓

2500 Pa Pressure Module  
MPR 2500

-

-

✓

✓

10 000 Pa Pressure Module  
MPR 10000

-

-

✓

✓



SCOH 112

✓

-

-

✓



Tachometry probe  
STA

-

✓

✓

✓

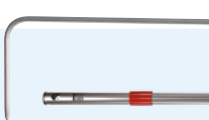

Type L Pitot tubes

✓

-

✓

✓



SFC 300

-

✓

✓

✓



SFC 900

-

✓

✓

✓



SH 100

-

✓

✓

✓



SHF 100

-

✓

✓

✓

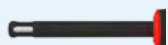

SHR 110

✓

✓

-

✓



SIPS 150

✓

✓

✓

✓



SPK 150

✓

✓

✓

✓

## Air velocity and airflow

At Sauermann, we have long recognised that air flow is a critical measurement in controlled-atmosphere environments – and that the air change rate (ACR), its associated parameter, is of crucial importance. That's why we designed the DBM 620 air flow meter specifically for this purpose: to easily calculate the ACR via the accompanying mobile app.

Air flow readings play a key role in making granular adjustments to pressure cascades in controlled-atmosphere buildings. This process, known as balancing, maintains extremely precise differential pressures (marginal differences of less than 15 Pa) in order to prevent the spread of contaminants without generating turbulence.

*"An air flow meter is the most versatile and effective handheld instrument for measuring vent air flow."*

Regularly replacing the air in a room – by bringing in a flow of fresh, filtered air from outside – is also the most effective way to reduce concentrations of chemical compounds, bacteria, viruses, aerosols and particles. Measuring the ACR is therefore equally important in ensuring that the air inside a confined space is clean and healthy.

An air flow meter is the most versatile and effective portable instrument for measuring air flow. It is compatible with all types of air vent – incoming and outgoing – and far outperforms other solutions when it comes to measurement accuracy.



Measures the incoming air flow through diffusers in a controlled-atmosphere environment.

**Solution**  
DBM 620









### An all-in-one measurement powerhouse

Differential pressure	Temperature	Humidity
Air velocity	Air flow	Air Change Rate (calculated)

# Transmitters







Our most common articles for clean rooms and regulated environments

	PRODUCT	ITEM	REF.	MEASURED PARAMETERS						DESCRIPTION
				Pa	°C/°F	%RH	m/s	m <sup>3</sup> /h	ppm	
Multifunction		Si-CPE320-W	27981	✓	✓	✓	✓	✓	✓	<p><b>Si-CPE320-W</b> Multifunction panel transmitter with wireless communication module</p> <ul style="list-style-type: none"> <li>Configurable range from -250 to +250 Pa (minimum configuration -25 to +25 Pa).</li> <li>Permanent auto-calibration solenoid valve.</li> <li>Pressure connection for calibration on front face.</li> <li>Three 0-5 V / 10 V or 0-20 mA / 4-20 mA analog outputs, 4-wire technology, input for interchangeable probes (probes come in option).</li> <li>Configuration of parameters, 3 sound alarms with cut-off via touch screen or via the Sauermann Control App, with mini-DIN connector on front face. Touch screen display, stainless steel front face.</li> <li>24 VAC/VDC power supply. Supplied with adjustment certificate.</li> <li>Coming in option: all interchangeable probes, calibration certificate.</li> </ul>
		Si-C320-D	27940	✓	✓	✓	✓	✓	✓	<p><b>Si-C320-D</b> Multifunction transmitter with 4 analogue outputs (0-5 V / 0-10 V or 0-20 mA / 4-20 mA), 4-wire technology</p> <ul style="list-style-type: none"> <li>24 VAC/VDC power supply. With touch screen display.</li> <li>2 inputs for Smart probes, and one location for Si-PRO-DP module.</li> <li>IP66 ABS V0 housing VHP resistant.</li> <li>Supplied with adjustment certificate.</li> <li>Coming in options: all interchangeable probes and all compatible Si-PRO-DP modules, calculation of the air velocity and airflow (SQR-3), and K thermocouple probes for Si-PRO-DP modules and calibration certificate.</li> </ul>
		Si-C320-D-50	27944	✓	✓	✓	✓	✓	✓	<p><b>Si-C320-D-50</b> Multifunction transmitter with differential pressure module, solenoid valve and K thermocouple connector</p> <ul style="list-style-type: none"> <li>Range: -50 to +50 Pa, supplied with pressure connectors, silicone tube and adjustment certificate.</li> </ul>
		Si-C320-D-1000	27946	✓	✓	✓	✓	✓	✓	<p><b>Si-C320-D-1000</b> Multifunction transmitter with interchangeable differential pressure module, solenoid valve and K thermocouple connector</p> <ul style="list-style-type: none"> <li>Range: -1000 to +1000 Pa, supplied with pressure connections, silicone tubes and adjustment certificate.</li> </ul>
Pressure		CP211-BO-R	25631	✓	✓	-	✓	✓	-	<p><b>CP211-BO-R</b> Differential pressure transmitter</p> <ul style="list-style-type: none"> <li>ABS V0 IP65 housing. 24 Vdc/Vac power supply with galvanic isolation.</li> <li>19-digit 2-line display with backlight and trend indicator. Configuration via keypad. Measuring range -100 to 100 Pa with solenoid valve and -100 to +400°C.</li> <li>Terminal block for Pt100 remote probe. 2 analogue outputs, 4-wires 0-1/5/10 V or 0/4-20 mA, 2 relays.</li> <li>Coming in option: LCC-S configuration software and SQR3 air velocity and airflow calculation function.</li> </ul>
		CP111-AN	23903	✓	-	-	-	-	-	<p><b>CP111-AN</b> Differential pressure transmitter</p> <ul style="list-style-type: none"> <li>ABS V0 IP65 housing with easy-mounting system.</li> <li>Without display.</li> <li>Measuring range: -100 à 100 Pa with solenoid valve.</li> <li>4-20 mA or 0-10 V output. 24 VDC or 24 VAC power supply.</li> <li>Coming in option: LCC-S configuration software.</li> </ul>
		CP111-AO	23902	✓	-	-	-	-	-	<p><b>CP111-AO</b> Differential pressure transmitter</p> <ul style="list-style-type: none"> <li>ABS V0 IP65 housing with easy-mounting system. 10-digit display.</li> <li>Configurable range: -100 to 100 Pa with solenoid valve.</li> <li>4-20 mA or 0-10 V output. 24 VDC or 24 VAC power supply.</li> <li>Coming in option: LCC-S configuration software.</li> </ul>











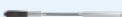

# Transmitters

Our most common articles for clean rooms and regulated environments

	PRODUCT	ITEM	REF.	MEASURED PARAMETERS							DESCRIPTION
				Pa	°C/°F	%RH	m/s	m³/h	ppm		
Pressure		HP 5 E6	25401	✓	-	-	-	-	-	<b>HP5 E6</b> Inclined liquid column manometer • Range: 0-50 Pa, supplied with connectors n° 487, AWS10 liquid and a wall-mounting plate.	
		HP 10 E6	25402	✓	-	-	-	-	-	<b>HP10 E6</b> Inclined liquid column manometer • Range: 0-100 Pa, supplied with connectors n° 487, AWS10 liquid and a wall-mounting plate.	
Temperature and humidity		TH110-POD	23952	-	✓	✓	-	-	-	<b>TH110-POD</b> Relative humidity and temperature transmitter • ABS V0 IP65 housing with easy-mounting system. • 10-digit display, ABS remote probe length 150 mm and 2 m cable. • Measuring range from 5 to 95%RH and -20 to 80°C, 4-20 mA output and 16 to 30 VDC power supply (passive 2-wire). • Coming in option: LCC-S configuration software.	
		TH210-BODI150-R-05M	26497	-	✓	✓	-	-	-	<b>TH210-BODI150-R-05M</b> Humidity and temperature transmitter • ABS V0 IP65 housing, with 20-digits display, remote probe made of stainless steel with 150 mm stainless steel filter and 5 m cable. • Measuring range from 5 to 95%RH and -40 to 180°C. • 2 x analogue outputs 4-wire technology 0-5/10 V or 0/4-20 mA, 2 relays and 24 VDC/VAC power supply with galvanic isolation. • Coming in option: LCC-S configuration software.	
		TH210-BOSP-R	25648	-	✓	✓	-	-	-	<b>TH210-BOSP-R</b> Temperature and hygrometry transmitter • ABS V0 IP65 housing, with 19-digit 2-line display, with backlight and trend indicator. • Ambient probe made of polycarbonate with stainless steel filter length 100 mm. • Measuring range from 5 to 95%RH and -20 to 80°C. • 2 analogue outputs 4-wire technology 0-1/5/10 V or 0/4-20 mA, 2 relays and 24 VDC/VAC power supply with galvanic isolation. • Coming in option: LCC-S configuration software.	
Air velocity and flow rate		CTV110-AOD300	23921	-	✓	-	✓	-	-	<b>CTV110-AOD300</b> Temperature and air velocity transmitter • ABS V0 IP65 housing with easy-mounting system, 10-digit display, and remote hotwire probe made of polycarbonate length 300 mm and 2 m cable. • Measuring range: from 0 to 30 m/s and 0 to 50°C. • Two 4-20 mA outputs (active 3-4 wire) and 24 VDC or 24 VAC power supply. • Coming in option: LCC-S configuration software.	
		CTV110-ANA300	23927	-	✓	-	✓	-	-	<b>CTV110-ANA300</b> Temperature and air velocity transmitter • ABS V0 IP65 housing with easy-mounting system, without display. • Duct mounting hotwire probe made of polycarbonate length 300 mm. • Measuring range: from 0 to 30 m/s and 0 to 50°C. • Two 4-20 mA outputs (active 3-4 wire) and 24 VDC or 24 VAC power supply. • Coming in option: LCC-S configuration software.	

# Accessories

ACCESSORIES	ITEM	REF	MEASURED PARAMETERS						DESCRIPTION
			Pa	°C/°F	%RH	m/s	m <sup>3</sup> /h	ppm	
	Si-PRO-V-300	27989	-	✓	-	✓	✓	-	<b>Si-PRO-V-300</b> Interchangeable hotwire probe for air velocity and temperature measurements. Stainless steel body length 267 mm, Ø 8 mm. <ul style="list-style-type: none"> <li>• Measuring range: 0 to 30 m/s and 0 to 50°C, with autolock connector.</li> <li>• Supplied with adjustment certificate.</li> </ul>
	Si-PRO-U-I-150	27984	-	✓	✓	-	-	-	<b>Si-PRO-U-I-150</b> Interchangeable hygrometry probe. Stainless steel body with stainless steel filter. For Si-C320 and Si-CPE320 <ul style="list-style-type: none"> <li>• Remote probe length 150 mm, Ø 13 mm.</li> <li>• Measuring range: 0 to 100%RH and -40 to +150°C, with autolock connector.</li> <li>• Supplied with adjustment certificate.</li> <li>• Coming in option: protection tip and filters.</li> </ul>
	Si-ACC-R5	28000	-	-	-	-	-	-	<b>Si-ACC-R5:</b> 5 m extension for class 320 interchangeable probes.
	Si-ACC-R2	27999	-	-	-	-	-	-	<b>Si-ACC-R2:</b> Connection cable for Si-PRO-U-I-150 temperature/humidity probe.
	Si-ACC-RVP	28002	-	-	-	-	-	-	<b>Si-ACC-RVP:</b> Connection cable for Si-PRO-V-300 air velocity probe.
	SF50-PS-2-100	25997	-	✓	-	-	-	-	<b>SF50-PS-02-6-100</b> Pt100 class A temperature probe (3 wires) <ul style="list-style-type: none"> <li>• Probe Ø 6 mm - Lg. 100 mm. PVC cable - 2 m length.</li> <li>• Operating temperature: -40°C to +105°C.</li> </ul>
	SF50-TS-5-100	26051	-	✓	-	-	-	-	<b>SF50-TS-05-6-100</b> Pt100 class A temperature probe (3 wires) <ul style="list-style-type: none"> <li>• Probe Ø 6 mm - 100 mm length.</li> <li>• PTFE cable - 5 m length.</li> <li>• Operating temperature: -50°C to +260°C.</li> </ul>
	BFP-13	18401	-	-	-	-	-	-	<b>BFP-13</b> mounting bracket made of PETP, for temperature probes Ø 13 mm <ul style="list-style-type: none"> <li>• Supplied with screws and fixing pins.</li> </ul>

ACCESSORIES	ITEM	REF	MEASURED PARAMETERS						DESCRIPTION
			Pa	°C/°F	%RH	m/s	m <sup>3</sup> /h	ppm	
	DP339	11090	-	-	-	-	-	-	DP339 connection for double-shell wall, max. thickness 80 mm.
	DP447	10388	-	-	-	-	-	-	DP447 connection for double-shell wall, max. thickness 30 mm.
	LCC-5	24106	-	-	-	-	-	-	<b>LCC-5:</b> Configuration software <ul style="list-style-type: none"> <li>• For Monostat, class 110 / 210 and 310 transmitters.</li> <li>• Supplied with USB cable and user manual.</li> </ul>
	SQR/3	24105	-	-	-	✓	✓	-	Factory activation of the <b>SQR/3</b> square root extraction function for the the air velocity and air flow calculation, from the differential pressure measurement. <ul style="list-style-type: none"> <li>• For CP 210-R transmitters.</li> <li>• Function activated by default in class 320 transmitters with differential pressure modules (Si-PRO-DP).</li> <li>• Activation carried out only in factory on new instruments (should be ordered together with the CP 210-R), or by the user after buying the instrument (please contact your sales representative for further details).</li> </ul>

### Customized Products



If you cannot find the product (instrument, probe, accessory) that suites your specific needs in this list, we can also deliver a large range of products that are available with longer delivery lead times.

# Data loggers

Our most common articles for clean rooms and regulated environments

All parameters

PRODUCT	ITEM	REF	MEASURED PARAMETERS						DESCRIPTION
			Pa	°C/°F	%RH	m/s	m <sup>3</sup> /h	ppm	
	KH-220-O	25238	-	✓	✓	-	-	-	<b>KH-220-O</b> Temperature/hygrometry/light datalogger <ul style="list-style-type: none"> <li>With internal sensor (-20 to +70°C, 5 to 95%RH, 0 to 10,000 lux).</li> <li>2-line display, IP40 protection housing with magnet fixing.</li> <li>1 external input for temperature/hygrometry/current/voltage/impulse and water pressure probe.</li> <li>Memory capacity: 1,000,000 measuring points.</li> </ul>
	KT220-O	25234	-	✓	✓	-	-	-	<b>KT220-O</b> Temperature datalogger <ul style="list-style-type: none"> <li>with internal sensor (-40 to +70°C).</li> <li>2-line display, IP65 protection housing, magnet fixing.</li> <li>1 external input for temperature/hygrometry/current/voltage/impulse and water pressure probe.</li> <li>Memory capacity: 1,000,000 measuring points.</li> </ul>
	KCC-320	25253	-	✓	✓	-	-	✓	<b>KCC-320</b> Temperature/hygrometry/atmospheric pressure/CO <sub>2</sub> datalogger <ul style="list-style-type: none"> <li>With internal sensor (-20 to +70°C, 5 to 95%RH, 800 to 1100 hPa and 0 to 5,000 ppm).</li> <li>2-line display, IP40 protection housing with magnet fixing and anti-theft wall-mounting support.</li> <li>Wireless communication for mobile and tablets applications (Android and iOS).</li> <li>Memory capacity: 2,000,000 measuring points.</li> </ul>
	KT-320	25248	-	✓	✓	-	-	✓	<b>KT-320</b> Temperature datalogger, with internal sensor (-40 to +70°C) <ul style="list-style-type: none"> <li>2-line display, IP65 protection housing with magnet fixing and anti-theft wall-mount support.</li> <li>2 external inputs for temperature/hygrometry/current/voltage/impulse probe.</li> <li>Wireless communication for mobile and tablets (Android and iOS).</li> <li>Memory capacity: 2,000,000 measuring points.</li> </ul>
	KITHA	25265	-	✓	✓	-	-	-	<b>KITHA</b> Ambient temperature/hygrometry probe <ul style="list-style-type: none"> <li>Smart probe (5 to 95%RH and -20 to +70°C).</li> <li>Probe body made of ABS length 95 mm with connector with stainless steel filter.</li> </ul>
	KITHP-130	25266	-	✓	✓	-	-	-	<b>KITHP-130</b> Remote temperature/hygrometry probe <ul style="list-style-type: none"> <li>Smart probe (5 to 95%RH and -20 to +70°C).</li> <li>Probe body made of ABS length 130 mm with stainless steel filter.</li> <li>PVC cable length 2 m with mini-DIN connector.</li> </ul>
	KTHA	25247	-	✓	✓	-	-	-	<b>KTHA</b> Ambient temperature/hygrometry probe <ul style="list-style-type: none"> <li>Interchangeable probe (5 to 95%RH and -20°C to +70°C).</li> <li>Probe body made of ABS, length 65 mm.</li> <li>With mini-DIN connector and stainless steel filter for class 220 Kistock.</li> </ul>
	KICA-320	27911	-	✓	-	-	-	-	<b>KICA-320</b> Adapter cable for other Pt100 temperature probes <ul style="list-style-type: none"> <li>3-wires, including one connection terminal block and one mini-DIN male connector.</li> <li>For Kistock KT 320 and KT TrackLog.</li> <li>To be mounted on already delivered probes (must be ordered alone - without probe).</li> </ul>
	KIC3-N	25244	-	-	-	-	-	-	<b>KIC3-N</b> configuration and dataprocessing software (Kilog 2015) <ul style="list-style-type: none"> <li>Supplied with CK-50 USB cable for Kistock (except KT-20 and class 120).</li> </ul>
	KBL-AA	25240	-	-	-	-	-	-	<b>KBL-AA</b> battery, AA Lithium 3.6 V <ul style="list-style-type: none"> <li>For Kistock class 220, 320 (2 batteries required on class 320).</li> </ul>

## Customized Products







If you cannot find the product (instrument, probe, accessory) that suits your specific needs in this list, we can also deliver a large range of products that are available with longer delivery lead times.













# Portable instruments







Our most common articles for clean rooms and regulated environments

Multifunction

PRODUCT	ITEM	REF	MEASURED PARAMETERS							DESCRIPTION
			Pa	°C/°F	%RH	m/s	m³/h	ppm		
	AMI310	24752	✓	✓	✓	✓	✓	✓	<p><b>AMI 310</b> Multi-function portable instrument with colour backlit graphic display</p> <ul style="list-style-type: none"> <li>• With 2 input channels for measuring probes and Pt100 temperature probes (-200 to +600°C).</li> <li>• 2 channels for K/J/T/S thermocouple input (-200 to +1760°C).</li> <li>• Output for PC and printer.</li> <li>• Supplied SOLE, with 2 cables with mini-DIN connector for measuring probes (in option).</li> <li>• 2 lithium ion rechargeable batteries, with USB / mains adapter cable, micro SD board for data storage, 2 x 1 m of silicone tube Ø 4 x 7 mm, one stainless steel tube Ø 6 mm length 100 mm, adjustment certificate and transport case.</li> <li>• Coming in option: all measuring modules, all measuring probes, all temperature probes (wire or wireless), software and printer.</li> </ul>	
	AMI310 PRO	24755	✓	✓	✓	✓	✓	✓	<p><b>AMI310 PRO</b> Multi-function portable instrument, with graphic backlit colour display</p> <ul style="list-style-type: none"> <li>• With 2 input channels for measuring probes and PT100 (-200 to +600°C) temp. probes, 2 K/J/T/N/S thermocouple input channels (-200 to +1760°C).</li> <li>• Output for PC and printer. Supplied with pressure module (- 500 to +500 Pa and 2 to 28 m/s), telescopic hotwire probe, length 1 m, with graduation, swivelling at 90° (0.15 to 30 m/s).</li> <li>• Stainless steel hygrometry probe (3 to 98 %RH and -40 to +180°C).</li> <li>• Ø 100 mm telescopic vane probe, length 1 m.</li> <li>• Swivelling at +/- 90° (0.3 to 35 m/s), Pitot tube length 300 mm, Ø 6 mm with integrated TCK temperature probe, 2 x 1 m of silicone tube (black and white), stainless steel tube Ø 6 mm length 100 mm, 2 cables with mini-Din connector, for measuring probes, 2 lithium ion rechargeable batteries, with USB/mains adapter cable.</li> <li>• Micro-SD board for data storage, calibration certificate and transport case.</li> <li>• Coming in option: all measuring modules and probes, all temperature probes software, printer.</li> </ul>	
	HQ210	24745	✓	✓	✓	-	-	✓	<p><b>HQ 210</b> Multi-probe portable thermo-hygrometer-air quality</p> <ul style="list-style-type: none"> <li>• With graphic backlit display, 2 input channels for measuring probe and Pt100 (-200 to +600°C) temperature probe, output for PC and printer.</li> <li>• Functions: hygrometry, temperature, CO and CO<sub>2</sub>.</li> <li>• Supplied SOLE, with 2 cables with mini-DIN connector for measuring probe (coming in option).</li> <li>• Lithium Ion rechargeable battery with USB cable / mains adapter, and transport case. Coming in option: climatic conditions modules, hygrometry and temperature probes (wire or wireless), CO/CO<sub>2</sub> probes, omni-directional probe, software.</li> </ul>	
	MP210	24730	✓	✓	-	✓	✓	-	<p><b>MP 210</b> Multi-probe portable thermo-anemo-manometer</p> <ul style="list-style-type: none"> <li>• With backlit graphic display, 2 input channels for measuring probes and Pt100 temperature probes (-200 to +600°C), output for PC and printer.</li> <li>• Functions: pressure, temperature, air velocity and airflow. Supplied SOLE, with 1 cable with mini-DIN connector, for measuring probes (coming in option), Lithium ion rechargeable battery with USB / mains adapter cable, 2 x 1 m of silicone tube 4 x 7, one stainless steel tube diam. 6 mm length 100 mm, transport case.</li> <li>• Coming in option: pressure modules, 4 thermocouple channels, air velocity and temperature probes (wire or wireless), CO, gas leak, tachometry, software and printer.</li> </ul>	
	VT210	24736	-	✓	✓	✓	✓	-	<p><b>VT 210</b> Multi-probe portable thermo-hygro-anemometer,</p> <ul style="list-style-type: none"> <li>• With graphic backlit display, 2 input channels for measuring probes and Pt100 (-200 to +600°C) temperature probes, output for PC and printer.</li> <li>• Functions: air velocity, airflow, hygrometry, temperature.</li> <li>• Supplied SOLE with 2 cables with mini-DIN connector for measuring probes (coming in option), Lithium ion rechargeable battery with USB cable / mains adapter, and transport case.</li> <li>• Coming in option: probes for air velocity, hygrometry and temperature (wire or wireless), multi-function probe, tachometry, 4 thermocouple channel and climatic conditions module, software and printer.</li> </ul>	

# Accessories





ACCESSORIES	ITEM	REF	MEASURED PARAMETERS						DESCRIPTION
			Pa	°C/°F	%RH	m/s	m <sup>3</sup> /h	ppm	
	TPL-06-300	12974	-	-	-	✓	✓	-	<b>Pitot tube type L, NPL model, as per ISO 3966 standard</b> <ul style="list-style-type: none"> <li>Type: <b>TPL-06-300</b>.</li> <li>Stainless steel body, length 300 mm, Ø 6 mm, with ellipsoidal head.</li> </ul>
	TPL-06-500	12975	-	-	-	✓	✓	-	<b>Pitot tube type L, NPL model, as per ISO 3966 standard</b> <ul style="list-style-type: none"> <li>Type: <b>TPL-06-500</b>.</li> <li>Stainless steel body, length 500 mm, Ø 6 mm, with ellipsoidal head.</li> </ul>
	BAT23	24849	-	-	-	-	-	-	<b>BAT 23 Lithium ion rechargeable batteries</b> <ul style="list-style-type: none"> <li>For class 210 and 310 instruments.</li> </ul>
	SCOH112	24776	-	✓	✓	-	-	✓	<b>SCOH-112 Multi-function probe for CO<sub>2</sub>, -temperature-hygrometry (0 to 5000 ppm / -20 to 80°C / 5 to 95%RH)</b> <ul style="list-style-type: none"> <li>With handle, multi-function button, integrated mini-DIN connector, Smart-2014 recognition system. Supplied with adjustment certificate.</li> <li>For HQ 210 and AMI 310.</li> </ul>
	SFC300	24759	-	✓	-	✓	✓	-	<b>SFC-300 Hotwire probe (0.15 to 30 m/s and 0 to +50°C)</b> <ul style="list-style-type: none"> <li>Stainless steel body, Ø 8 mm, length 300 mm.</li> <li>Smart-2014 recognition system. Supplied with adjustment certificate.</li> <li>For class 210 and 310 portable instruments.</li> </ul>
	SFC900	24760	-	✓	-	✓	✓	-	<b>SFC-900 Telescopic hotwire probe (0.15 to 30m/s and 0 to +50°C)</b> <ul style="list-style-type: none"> <li>Length 1m, with graduation, swivelling at 90°.</li> <li>With handle, multi-function button, integrated mini-DIN connector, Smart-2014 recognition system.</li> <li>Supplied with adjustment certificate. For class 210 and 310 portable instruments.</li> </ul>
	SH100	24767	-	✓	-	✓	✓	-	<b>SH-100 Ø 100 mm vane probe (0.3 to 35m/s and -20 to +80°C)</b> <ul style="list-style-type: none"> <li>With handle, multi-function button, integrated mini-DIN connector, Smart-2014 recognition system. Supplied with adjustment certificate.</li> <li>For MP 210, VT 210 and AMI 310.</li> </ul>
	SHF-100	24779	-	✓	-	✓	✓	-	<b>SHF-100 Wireless Ø 100 mm vane probe (0.3 to 35 m/s and -20 to +80°C)</b> <ul style="list-style-type: none"> <li>Wireless transmission system, with handle and multi-function button.</li> <li>Supplied with adjustment certificate. For class 210 and 310 instruments.</li> </ul>
	SHR110	24769	-	✓	✓	-	-	-	<b>SHR-110 ABS hygrometry probe (3 to 98%RH and -20 to +80°C)</b> <ul style="list-style-type: none"> <li>Length 110 mm, Ø 13 mm,</li> <li>With handle, multi-function button, integrated mini-DIN connector, Smart-2014 recognition system. Supplied with adjustment certificate.</li> <li>For HQ 210, VT 210 and AMI 310.</li> </ul>
	SPK 150	24650	-	✓	-	-	-	-	<b>SPK-150 K thermocouple penetration probe, class 1 (-40 to +250°C)</b> <ul style="list-style-type: none"> <li>Stainless steel probe Ø 4.5 mm, sharp tip, length 150 mm.</li> <li>With handle, retractable cable, miniature male compensated connector (Tr 99% : 30 sec).</li> </ul>
	SIPS150	24840	-	✓	-	-	-	-	<b>SIPS 150 Pt100 immersion temperature probe (-40 to +250°C)</b> <ul style="list-style-type: none"> <li>Stainless steel probe Ø 4.5 mm, length 150 mm, with handle.</li> <li>Integrated mini-DIN connector, Smart-2014 recognition system. Supplied with adjustment certificate. For Class 310 and 310 instruments (Tr 99%: 35 sec).</li> </ul>
	STA	24771	-	-	-	-	-	-	<b>STA Optical and contact tachometry probe (60 to 60,000 RPM, 30 to 20,000 RPM and 4 to 2500 m/min)</b> <ul style="list-style-type: none"> <li>With handle, multi-function button, integrated mini-DIN connector, Smart-2014 recognition system.</li> <li>Supplied with 1 m reflective tape, contact tip and adjustment certificate. Compatible with MP 210, VT 210 and AMI310.</li> </ul>
	RTE	24632	-	-	-	-	-	-	<b>RTE Ø 16 mm telescopic extension, length 1 m, can be bent at +/- 90°</b> <ul style="list-style-type: none"> <li>For measuring probes with handle.</li> </ul>

ACCESSORIES	ITEM	REF	MEASURED PARAMETERS							DESCRIPTION
			Pa	°C/°F	%RH	m/s	m³/h	ppm		
	RD300	12411	-	-	-	-	-	-	<b>RD300</b> straight extension, length 300 mm • For hot wire probe and vane probe Ø 14 mm.	
	MPR-500	24782	✓	✓	-	-	-	-	<b>MPR-500</b> pressure module, with 1 thermocouple K/J/T/N channel (-500 to +500 Pa, -200 to +1300°C). • With Smart-2014 recognition system. • Supplied with adjustment certificate. For MP 210 and AMI 310.	
	MPR-2500	24783	✓	✓	-	-	-	-	<b>MPR-2500</b> pressure module, with 1 thermocouple K/J/T/N channel (-2500 to +2500 Pa, -200 to +1300°C) • With Smart-2014 recognition system. • Supplied with adjustment certificate. For MP 210 and AMI 310.	
	MPR-10000	24784	✓	✓	-	-	-	-	<b>MPR-10000</b> pressure module, with 1 K/J/T/N thermocouple channel (-10,000 to +10,000 Pa, -200 to +1300°C) • With Smart-2014 recognition system. • Supplied with adjustment certificate. For MP 210 and AMI 310.	
	CSM	24837	-	-	-	-	-	-	<b>CSM</b> Braid cable with mini-DIN male connector • For measuring and Pt100 temperature probes. • For class 210 and 310 instruments.	
	SAD	24792	-	-	-	-	-	-	<b>SAD</b> Transport back-pack • For class 210 and 310 instruments and their accessories.	
	LPC-14	24789	-	-	-	-	-	-	<b>LPC-14</b> SOLE software, for class 210 and 310 instruments.	

## Airflow meters

Our most common articles for clean rooms and regulated environments

Air velocity and air flow

PRODUCT	ITEM	REF	MEASURED PARAMETERS							DESCRIPTION
			Pa	°C/°F	%RH	m/s	m³/h	ppm		
	DBM 620	26446	✓	✓	✓	✓	✓	-	<b>DBM620</b> Electronic airflowmeter • Measuring ranges from 35 to 4250 m³/h, -2500 to +2500 Pa, 0.2 to 10 m/s, 0 to 100%RH, -20 to 70°C • Removable wireless pressure measuring unit for use in micromanometer and anemometer mode with different probes (Pitot tube, Debimo blade, DBM VMG velocity grid). • Supplied with base including temperature and humidity probe, pressure measuring unit, 610 x 610 mm (2' x 2') hood including foldable frame and airflow straightener, frame rods with sheath, 2 x 80 cm of silicone tube. • Calibration certificate and transport case. The free SmartKapp mobile App is available for data reading and processing on smartphone or tablet.	
	HO-622	26451	-	-	-	✓	✓	-	<b>HO-622</b> Measuring hood for DBM620 • Sizes 720 x 720 mm (2,36' x 2,36') • Supplied with foldable frame and carrying bag.	
	HO-623	26452	-	-	-	✓	✓	-	<b>HO-623</b> Measuring hood for DBM620 • Sizes 720 x 1320 mm (2,36' x 4,33') • Supplied with foldable frame and carrying bag.	
	HO-624	26453	-	-	-	✓	✓	-	<b>HO-624</b> Measuring hood for DBM620 • Sizes 420 x 1520 mm (1,38' x 4,99') • Supplied with foldable frame and carrying bag.	
	HO-625	26454	-	-	-	✓	✓	-	<b>HO-625</b> Measuring hood for DBM620 • Sizes 1020 x 1020 mm (3,35' x 3,35') • Supplied with foldable frame and carrying bag.	

# Professional solutions for condensate management and indoor air quality measurement

## INsights

Case studies, useful information and practical advice for HVACR and indoor air quality professionals.

[sauer mann group.com/insights](https://sauer mann group.com/insights)

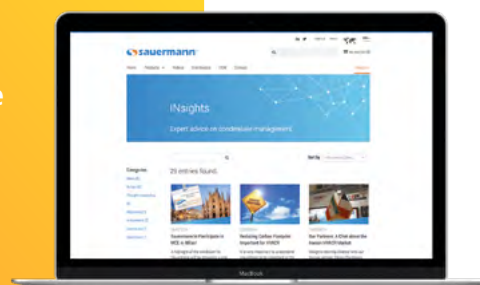

## Sauer mann on YouTube

Head to our YouTube channel for tutorials, webinars and product guides.

[youtube.com/sauer mann group](https://youtube.com/sauer mann group)

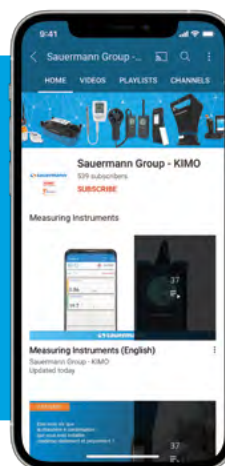

For more information, visit:  
[sauer mann group.com](https://sauer mann group.com)



Sauer mann Industrie S.A.S  
Route de Férolles  
77173 Chevry-Cossigny - France

[services@sauer mann group.com](mailto:services@sauer mann group.com)